



LEFEET S1 WATERSCOOTER USER MANUAL

Ver.1.0 01/01/20

In order to continue serving our customers and providing the best products, our product information including our user manuals may receive updates from time to time. Please check our website for the latest user manuals and product materials.

Thank you for your purchase of the LEFEET S1!

LEFEET S1 is a hi-tech water scooter which provides power propulsion to underwater divers. LEFEET S1 is easier to carry and use due to its compact and lightweight design, with 3 speed-settings to meet your needs. The modular design provides for diversification of use and a safer overall experience for you.

Have fun!

- LEFEET Team

TABLE OF CONTENTS

I - GENERAL INFORMATION

- 1.1 WHAT'S IN THE BOX? 4
- 1.2 SAFETY WARNINGS 5

II - PRODUCT FEATURES

- 2.1 PRODUCT DIAGRAM 7
- 2.2 REMOTE CONTROL DIAGRAM 8

III - ASSEMBLING

- 3.1 HANDLE ASSEMBLING 9
- 3.2 ASSEMBLING THE HANDLE BRACKET ONTO THE
MAIN UNIT 10
- 3.3 INSTALL AND REMOVE THE BATTERY 11

IV - CHARGING

- 4.1 HOW TO CHARGE THE LEFEET S112
- 4.2 HOW TO CHARGE THE REMOTE CONTROL13

V - HOW TO USE

- 5.1 HOW TO USE YOUR LEFEET S1 14
- 5.2 HOW TO TIE YOUR LOST-PREVENTION STRAP 15
- 5.3 HOW TO PAIR WITH THE MAIN UNIT AND THE
REMOTE CONTROL16

VI - MAINTENANCE

- 6.1 CLEAN ISSUES 18
- 6.2 STORAGE 19
- 6.3 DISPOSAL AT END-OF-LIFE 19

VII - SPECIFICATIONS

- LEFEET S1 SPECIFICATIONS 20

WARRANTY SERVICE

I - GENERAL INFORMATION

Before using your LEFEET S1, please read all instructions. This manual will guide you through the functions, usage, and proper care of your LEFEET S1. If you have any question or cannot find the information you need in the manual, please feel free to contact us through: service@lefeet.com. Before contacting customer service, please have your purchase information ready as this may be needed during the service.

When reading this manual, note these icons:



Notes with this icon **MUST** be read, understood, and obeyed to prevent injury or damage, etc.



Notes with this icon include relevant information.

1.1 WHAT'S IN THE BOX?

1. Main Unit Cover x 1
2. Main Unit x 1
3. Remote Control x 1
4. Handle x 2
5. Handle Knob x 1
6. Quick-Disassemble Screws x 2
7. Handle Bracket x 1
8. Battery x 1
9. Battery Charger x 1
10. O Ring (Spare) x 1
11. Remote Control Charge Cable x 1
12. Lost-prevention Strap x 1
13. Quality Certificate x 1
14. User Manual x 1

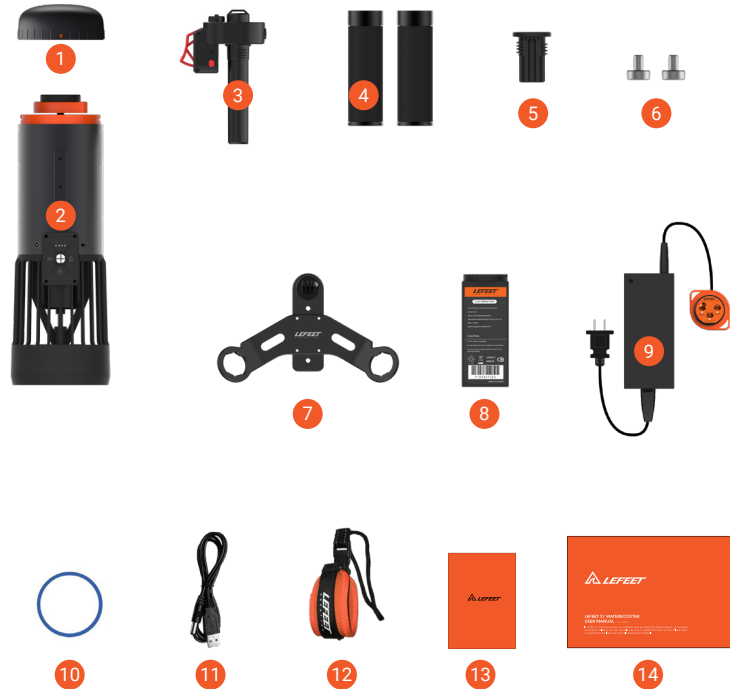

Fig. 1

1.2 SAFETY WARNINGS

The LEFEET S1 has been designed with the utmost safety in mind for its users. However, as with any scooter product, the LEFEET S1 has inherent hazards associated with its use (for example: losing control). Therefore, it is important to read and follow all instructions and warnings in the user manual and use good judgment when using the scooter.

By using the LEFEET S1, the user acknowledges and accepts responsibility of all risks associated with the use of the LEFEET S1, which may include, but are not limited to, muscle injuries, broken bones, lacerations, or other serious injuries.

Use the LEFEET S1 at your own risk. We are not responsible for mishaps due to lack of common sense.

To better ensure your safety, ALWAYS USE APPROPRIATE PROTECTIVE GEAR, read and follow all instructions and warnings in the user manual.



- This product is entertainment equipment, it can not be used as lifesaving equipment.
- This product only can be used in water. Please don't operate LEFEET S1 in the air, otherwise, it will be burned down due to overheat.
- Any accessories of this product should not be close to the fire source and should not be under heavy pressure.
- The surface of the product shall not contact with volatile, acidic, corrosive substances or sharp objects.
- Do not place any part of the body or foreign matter near the propeller when the product is equipped with batteries.
- After-sales service and repair can only be carried out by the authorization center. Unauthorized repair will invalidate the warranty,
- at the same time, there is a risk of personal safety and damage to the product function.

- Minors under 14 years of age shall not use this product. Minors who have reached the age of 14 should use this product under the escort of a guardian.
- Do not use this product if you are not fit for swimming, snorkeling or diving.
- Do not use this product under the influence of alcohol or drugs.
- Before using this product, make sure that the water is suitable for swimming, diving, etc., and that this product is allowed.
- Before using this product, check that the surface of the product is not damaged, the battery is not damaged, and the propeller is working properly to ensure that the product has enough power to return to the shore safely.
- Before using this product for diving, please confirm that you are qualified for diving, you must be equipped with life-saving equipment, take protective measures, and do it under the condition of being accompanied.
- Users who do not know how to swim should use this product in shallow water areas and confirm that other life-saving equipment is available or that a swim/life-saving instructor is present.
- When using this product, please wear life jacket or life-saving equipment, wear swimming cap, do not wear loose clothes, and keep a safe distance from the surrounding long hair or wearing loose clothes, avoid long hair or clothes involved in the propeller.
- While using this product, please hold the handle tightly and do not point the front and the tail of the product to the face of you or others, especially the eyes.
- When using this product, pay attention to the surrounding environment in order to avoid collision, do not let algae rope or other debris wrap around the propeller.
- Do not try this product directly on the beach to avoid sand, shells or other debris being brought into the propeller.
- This product is forbidden to dive to waters exceeding 40 meters in depth.
- Use only the charging accessories provided by the manufacturer. Other chargers are not allowed.
- The temperature range within which the battery can be charged is 50°F ~ 113°F.
- The battery can not be disassembled and modified, and it can not be subjected to strong vibration and shock. After the battery is installed, please take it lightly.
- The battery should not be damp, and the battery metal socket should not touch any liquid. When you install, remove and store battery, please keep this product and your hands completely dry in a dry environment.
- If, during using or charging, the battery gives off an unusual odor, heat, change color, shape, or any other abnormality, please stop using or charging immediately. Please check the storage environment if the above abnormal conditions occur during battery storage.
- Do not place the battery in microwave ovens, high-pressure containers, or on induction cookware.
- Do not place the battery in direct sunlight or use or store the battery inside cars in hot weather.
- In the event that the battery leaks and the fluid gets into one's eye, do not rub the eye. Rinse well with water and immediately seek medical care. If left untreated, the battery fluid could cause damage to the eye.

II - PRODUCT FEATURES

2.1 PRODUCT DIAGRAM

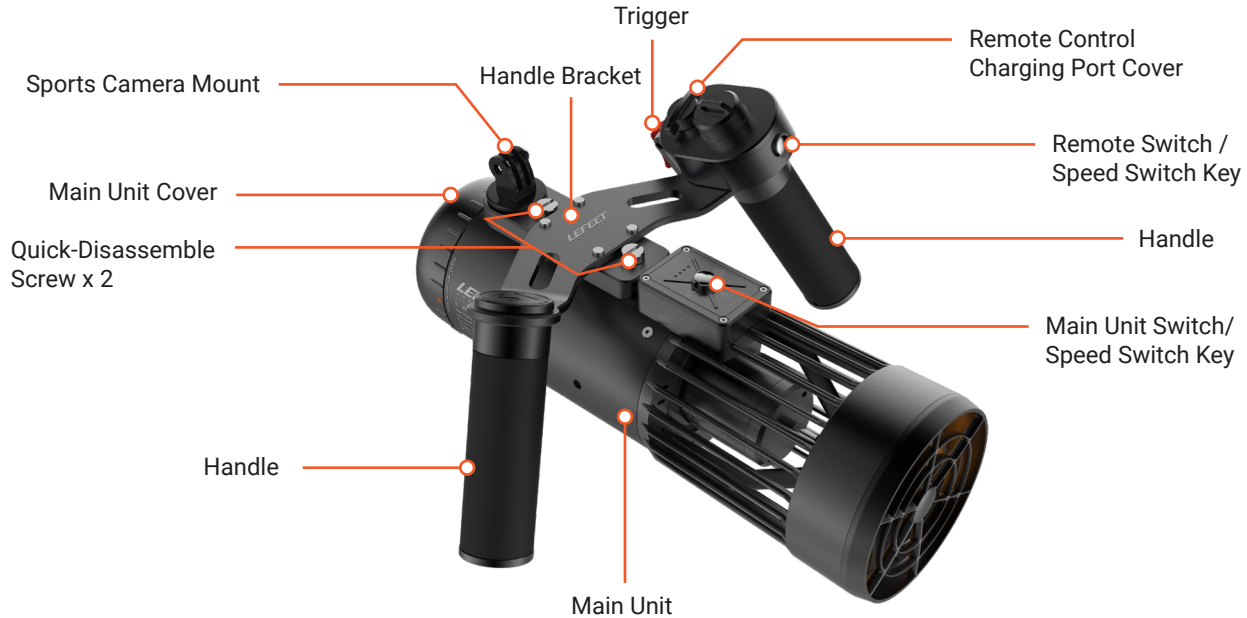

Fig. 2

2.2 REMOTE CONTROL DIAGRAM

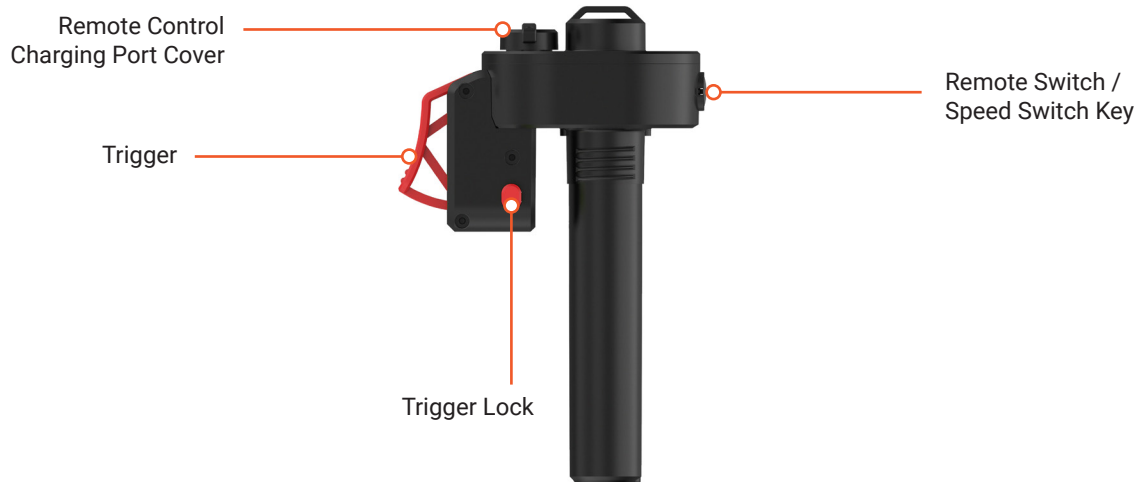

Fig. 3

III - ASSEMBLING

3.1 HANDLES ASSEMBLING



- Before using the LEFEET S1, make sure the **Handles** are tightened with **Handle Knob** and **Remote Control**.
- The instructions of this step are only for right-handed users. In fact, the left and right positions of the **Remote Control** can be adjusted according to users' habits.

STEP 1. Take out the two **Handles**, **Handle Knob**, **Handle Bracket** and the **Remote Control** from the package.

STEP 2. Kindly pay attention to check the front and back directions of the **Remote Control** installation, so that the **Trigger** of the **Remote Control** is back against yourself (Fig. 4).

STEP 3. Insert the **Handle Knob** into the hole on left side of the **Handle Bracket**. Align to the **Handle** and insert the **Handle Knob** into one of its tube.

STEP 4. Anticlockwise screwing the **Handle** when inserting it.

STEP 5. Insert the **Handle Knob** into the left side hole of **Handle Bracket**, screwing tight with another **Handle**.



Fig. 4



Fig. 5

3.2 ASSEMBLING THE HANDLE BRACKET ONTO THE MAIN UNIT

- STEP 1.** Align the track on the **Main Unit** and the track hole on the **Handle Bracket**. Slide the **Handle Bracket** onto the **Main Unit** along with the track to calibrate the holes.
- STEP 2.** Take out two **Quick-Disassemble Screws** and fasten them to the **Main Unit** (install with coins or similar items).



Fig. 6

3.3 INSTALL AND REMOVE THE BATTERY

- STEP 1.** Open the **Battery Cover**, and insert the battery into the compartment (Fig. 7).
- STEP 2.** Carefully align the Battery Pins on the battery, then fit them together (Fig. 7).
- STEP 3.** Make sure the **Battery Cover** is properly pressed tight, clockwise rotate it 45° to lock the battery in place. While anti-clockwise rotate it, the battery will be unlock (Fig. 8).
- STEP 4.** Clockwise the **Main Unit Cover** on the top of the **Main Unit** and screw it tight (Fig. 9).
Let the orange arrow which is on the Main Unit Cover aim at the "OPEN" sign on the Main Unit and then press, screw clockwise; it represents locked when the orange arrow aims at "LOCK" sign and comes out a sound.
- STEP 5.** Reverse operations to remove the battery.

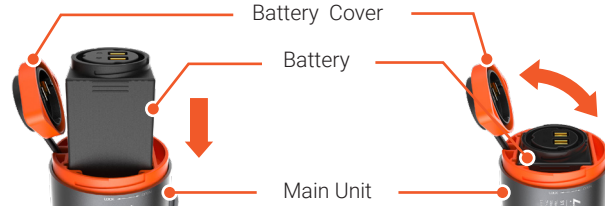

Fig. 7



Fig. 8



Fig. 9

IV - CHARGING



- Please make sure the battery is fully charged before first use.
- Please make sure the **Main Unit** is turned off before you remove the battery (see section 3.3).

4.1 HOW TO CHARGE THE LEFEET S1

- STEP 1.** Connect the plug pins (a) of **Battery Charger** with AC power (100V-240V; Use the power adapter conversion if necessary).
- STEP 2.** Fasten the plug pins (b) at the other end of the **Battery Charger** to the battery slot and tighten.
- STEP 3.** The red light of the **Battery Charger** represent that the battery is not fully charged, and green indicates that the battery is fully charged. The charging time is about 2.5 hours.

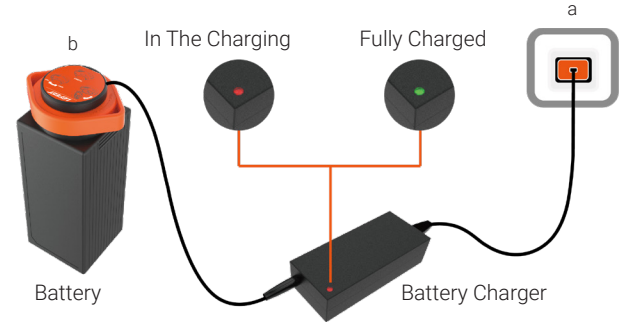

Fig. 10



- Please unplug the **Battery Charger** when it is not charged.

4.2 HOW TO CHARGE THE REMOTE CONTROL



- Make sure the **Remote Control** is turned off before charging.
- Do not under any circumstances use the **Remote Control** while it is charging or connected to the adapter.

STEP 1. Follow the arrow to rotate the cover on top of the **Remote Control** to remove it.

STEP 2. Please use 5V/1A power adapter or standard USB charge port to charge(Not provided).

Insert one end of the **Remote Control Charge Cable** into the **Remote Control** and the other end into the USB port.

STEP 3. When the **Remote Control** is fully charged, the light will turn green, disconnect the **Remote Control** from the adapter. The charging time is about 1.5 hours.

STEP 4. After charging, please turn the cover back and screw it.



Fig. 11

V - HOW TO USE

5.1 HOW TO USE YOUR LEFEET S1

- STEP 1.** Make sure that **Trigger Lock** is under unlock state (**Trigger** can be pressed normally).
- STEP 2.** Separately press the **Switch/ Speed Switch Key** for ~1s on **Remote Control** and **Main Unit** to power on your LEFEET S1.
- STEP 3.** Short press one of **Switch/ Speed Switch Key** of **Remote Control** or **Main Unit** to switch three speed settings.
(Low 🐢 , Medium 🐌 , High 🚀)*.

Operating Time:

30~60 mins (Normal Using)

* **Note:** As the battery power is used up, the power of LEFEET S1 will gradually weaken, and there will be an automatic speed reduction and speed shift. Even if the device is unable to be used at high or medium speed setting, this is a normal condition and should not be cause for worry .

- STEP 4.** Press the **Trigger** to run LEFEET S1, release it down to decelerate and stop .
- STEP 5.** Press both **Switch/ Speed Switch Key** on **Remote Control** and **Main Unit** for 1 second to power off your LEFEET S1.

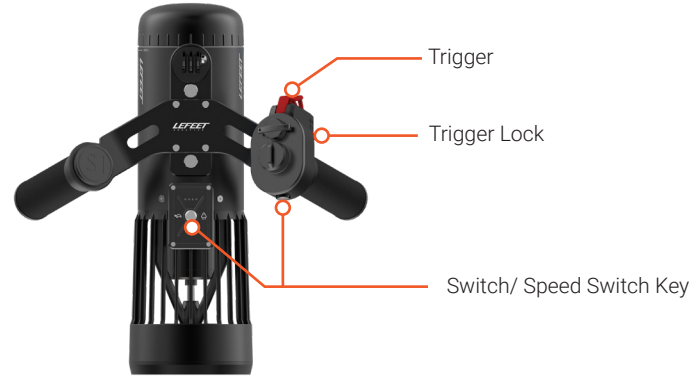

Fig. 12



If the **Main Unit** and **Remote Control** have no response in fifteen minutes, they will be shut down automatic.

5.2 HOW TO TIE YOUR LOST-PREVENTION STRAP



· The **Lost-Prevention Strap** is only used to prevent the product from getting out of hand underwater. It is not suitable for lifting products on shore.

STEP 1. Separate the **Lost-Prevention Strap** into section a and b from the buckle (Fig. 13).



Fig. 13

STEP 2. Tear off the Hook&Loop in part a and wrap the smooth side around the wrist. Insert the Hook&Loop into the buckle and press it tightly (Fig. 14).



Fig. 14

STEP 3. Put part b through the hole of **Handle Bracket** and fasten it tightly (Fig. 15).

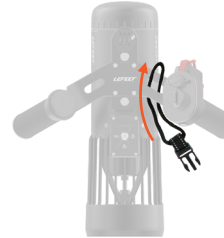

Fig. 15

STEP 4. Please press the buckle which connects section a and b tightly (Fig. 16).



Fig. 16

5.3 HOW TO PAIR WITH THE MAIN UNIT AND THE REMOTE CONTROL

The **Remote Control** and **Main Unit** are paired by default in factory setting. If not, please follow the steps as below.

- STEP 1.** Long press the **Remote Switch/Speed Switch Key** on **Remote Control** for 5 seconds, the white light will flash quickly, the **Remote Control** enters pairing mode.
- STEP 2.** Long press the **Main Unit Switch/Speed Switch Key** on **Main Unit** for 5 seconds until the white light for three speed settings flash quickly, the **Main Unit** enters pairing mode.
- STEP 3.** When the three speed settings indicator light on the **Main Unit** stops flashing, the propeller will rotate briefly, the **Main Unit** and the **Remote Control** have been paired successfully.
- STEP 4.** Short press the **Remote Switch/Speed Switch Key** on **Remote Control**, the white light will stop flash and turn into green, the **Remote Control** exits pairing mode.



Fig. 17



- One **Remote Control** can also be paired with multiple **Main Units** with above method.

VI - MAINTENANCE

In order to maintain good performance, please refer to the following steps for maintenance after each use:

- STEP 1.** Immerse the LEFEET S1 in a container full of clean water (not seawater) for 30 minutes.
- STEP 2.** Hold the **Handles** with both hands and turn it on with slow speed for one minute and repeat it for 2~3 times while the product is completely immersed into water.
- STEP 3.** Dry the **Main Unit** with a soft, clean, dry cloth.
- STEP 4.** Open the cover of the **Main Unit**, wipe off the water droplets outside the battery compartment, open the **Battery Cover** when both hands are dry, taking out the battery.
- STEP 5.** Place the **Main Unit** and battery in a cool and ventilated place to dry completely.

6.1 CLEAN ISSUES

You'd better pull out the **Propeller Cover** for cleaning if the propeller is entangled by other things.



- Please make sure that the power is turned off and the battery is removed before doing the below operations.
- Mind your fingers when you are cleaning the dirt in propeller.
- Please don't break the propeller while cleaning as it is necessary accessory.

STEP 1. Rotate the **Propeller Cover** on the bottom of LEFEET S1 anticlockwise and pull out the cover (please be careful of your intensity in case of damage).

STEP 2. Rotate the propeller to clean the dirt.

STEP 3. Reverse operations after completing the above step.



Fig. 18

6.2 STORAGE

- Please do not store LEFEET S1 in too high or too low temperature, too dry or too wet, direct sunlight and dust environment, which may cause damage over time.
- Please fully charge LEFEET S1 before storing to prevent over discharge when it doesn't in use.
- If not in use for long time, please recharge the battery every three months.
- The storage temperature should not exceed the range of 14° F ~ 122° F.

6.3 DISPOSAL AT END-OF-LIFE

This product must not be disposed of by incineration, landfilling, or mixing with household trash. Improper disposal of the battery contained within this product may result in the battery heating up, rupturing, or igniting which may cause serious injury. The substances contained inside the battery present chemical risks to the environment. The recommended disposal for any LEFEET S1 at its end-of-life is to dispose of the entire unit at or through an e-waste recycling center, program, or facility.

Local regulations and laws pertaining to the recycling and disposal of lithium-ion batteries and/or products containing them will vary according to country, state, and local governments. You must check laws and regulations corresponding to where you live in order to properly dispose of the battery and/or unit. It is the user's responsibility to dispose of their waste equipment properly with accordance with local regulations and laws.

For additional information about where you should drop off your batteries and electrical or electronic waste, please contact your local or regional waste-management office, your household waste disposal service, or your point-of sale.

VII - LEFEET S1 SPECIFICATIONS

	ITEM	PARAMETERS
Main Unit	Net Weight	5.07 lb (Including Battery)
	Dimensions	12.4 x 11.8 x 6.5 in (Including Handle Bracket)
	Working Temperature	32°F ~ 104°F
	Waterproof Depth	131.2 ft
	Speed Settings	Three settings: Low / Medium / High *
	Operating Time	30 ~ 60 mins (Normal Using) *
	Thrust	15.4 lbf
	Add-on Support	Support add-on sports camera *

- * Note:**
1. As the battery power is used up, the power of LEFEET S1 will gradually weaken, and there will be an automatic speed reduction and speed shift. Even if the device is unable to be used at high or medium speed setting, this is a normal condition and should not be cause for worry;
 2. All the parameters are for reference only. The specific battery life will vary depend on your selection of speed settings, the user's body weight, as well as the environment and frequency of use;
 3. The Sports Camera Mount of this product only supports some types of sport cameras, while mounts for other types of cameras should be purchased separately.

Battery	Charging Voltage	25.2 V
	Charging Current	3 A
	Rated Capacity	4400 mAh
	Rated Energy	97.68 Wh
	Charging Temperature	50°F ~ 113°F
	Charging Time	~ 2.5 h
	Net Weight	1.68 ± 0.044 lb
Battery Charger	Input Voltage	100 ~ 240 V
	Output Voltage	25.2 V
	Output Current	3 A

WARRANTY SERVICE

Dear Customers:

LEFEET guarantees that the LEFEET S1 products you purchase are designed and manufactured according to the qualified standards. Under normal use, there is no functional defect during the warranty period. If you have any problem in the process of using, we recommend that you first check the user manual, furthermore, you can also download the user manual, FAQ, instructional video or support forum on our website.

SCOPE OF SERVICES

Your LEFEET S1 includes a one-year limited hardware warranty which starts from the date of the sales invoice, the warranty period of the main body is 12 months while the warranty period of the battery is 6 months. If you cannot provide invoice or other valid proof of purchase, then the warranty period will start from 90 days after the production date that shows on the product, or otherwise specified by LEFEET.

If repairs are not feasible or commercially unfeasible, we may replace this product with new or refurbished products with similar features. After repair, firmware upgrade and replacement, the replaced product or accessory will be covered by the same warranty during the remaining warranty period of the original product.

HOW TO OBTAIN AFTER-SALES SERVICE

If a product does not function as warranted during the warranty period, please contact us through service@lefeet.com to obtain after-sales service.

LEFEET may not offer after-sales service in some area, the policy of after-sales service varies from different places. Additional charges may be required for services outside the regular service scope. Please contact us for information specific to your location.

WHAT TO DO BEFORE OBTAINING AFTER-SALES SERVICE

Please specify the problems with the product after contacting LEFEET.

LEFEET technician will attempt to diagnose and resolve your problem by phone, email, or remote assistance. If your problem cannot be resolved over the telephone, you may be required to deliver the product to LEFEET for further examination. LEFEET will arrange for repair or replacement service under this Limited Warranty Service.

PRODUCT AND PART REPLACEMENT

When after-sales service involves the replacement of a product or part, the replaced product or part becomes LEFEET's property and the replacement product or part becomes your property. Only unaltered LEFEET products and parts are eligible for replacement.

Replacement products or parts provided by LEFEET may not be new, but it will be in good working order and at least functionally equivalent to the original product or part's warranty. A replacement product or part shall be covered for the time remaining in the original product's warranty.

USE OF PERSONAL CONTACT INFORMATION

If you obtain service under this policy, you authorize LEFEET to store, use, and process your contact information, including name, phone numbers, address, and e-mail address. You agree and understand that it is necessary for LEFEET to collect, process and use your information to perform service under this policy. We may contact you to inquire about your satisfaction with our service or to notify you about any product recalls or safety issues.

In order to achieve these aims, you authorize LEFEET to transfer your information to any country where we do business and to provide it to entities acting on our behalf. We may also disclose your information where required by law.

WHAT THIS AFTER-SALES POLICY DOES NOT COVER

This policy does not cover the following:

- Collision or burning down accidents caused by man-made and non-product quality problems.
- Damage caused by unauthorized modification and dismantling of the shell under the guidance of the unofficial instruction manual.
- Damage caused by improper installation, use and operation not according to the user manual.
- The customer repairs the parts by himself or asks an unauthorized service organization to repair/modify the parts without official instructions.

- Damage caused by improper circuit modification guided by unofficial user manual and mismatch or misuse of the battery and charger.
- Damage caused by misuse of the product or handling of the product under environmental conditions not in accordance with the user manual.
- Damage due to peripherals, add-on devices, or accessories other than those recommended in the user manual.
- Damage caused by insufficient discharge when the battery is low or when using a battery with quality problems.
- The device has been damaged, including but not limited to damage caused by animals, lightning, abnormal voltage, fire, natural disasters and transportation.
- Products or parts with an altered identification label or from which the type number, serial number, production date has been removed or unrecognizable.
- The product cannot work properly because it is not used in the country/area where it was originally designed and manufactured or approved for use.
- For third-party applications that you use on the product.

LIMITATION OF LIABILITY

LEFEET only take charge of the loss or damage under following circumstances: Your product is owned by LEFEET or it is in LEFEET's transportation. Under no circumstance, and notwithstanding the failure of essential purpose of any remedy set forth herein, shall LEFEET, its affiliates, suppliers, dealers, or service providers be liable for any of the following even if informed of their possibility and regardless of whether the claim is based in contract, warranty, negligence, strict liability or other theory of liability: 1) Third party claims against you for damages; 2) Special, incidental, punitive, indirect or consequential damages, including but not limited to lost profits, business revenue, goodwill or anticipated savings.

In no case shall the total liability of LEFEET, its affiliates, suppliers, dealers, or service providers for damages from any cause exceed the amount of actual direct damages, not to exceed the amount paid for the product.



LEFEET
LEFEET S1 WATERSCOOTER

感谢您购买 LEFEET S1 !

LEFEET S1 是一款能够在水下为你提供动力推进的科技产品。它轻便小巧的设计令你更易于携带和使用，并提供三种速度模式满足不同需求，同时还采用模块化设计带来更多元化的使用方式。期待 LEFEET S1 能带给您一种全新的体验。

祝您使用愉快！

—— LEFEET 团队

目录

I - 基本资料

- 1.1 包装清单 4
- 1.2 安全警告 5

II - 产品特性

- 2.1 产品图示 7
- 2.2 遥控器图示 8

III - 组装

- 3.1 手柄组装 9
- 3.2 手柄支架与主机组装 10
- 3.3 组装或拆卸电池 11

IV - 充电

- 4.1 如何为 LEFEET S1 充电 12
- 4.2 如何为遥控器充电 13

V - 如何使用

- 5.1 如何使用你的 LEFEET S1 14
- 5.2 如何系挂防丢绳 15
- 5.3 如何使主机与遥控器配对 16

VI - 维护

- 6.1 清理事项 18
- 6.2 存放 19
- 6.3 设备处理 19

VII - 规格

- LEFEET S1 规格 20

保修服务

I - 基本资料

这本《使用说明书》将指引您了解 LEFEET S1 的功能、用法和正确使用的规范，在使用 LEFEET S1 之前请仔细阅读全部内容。如果您有任何疑问或无法在该手册中找到您所需要的信息请联系 LEFEET 客户服务邮箱：service@lefeet.com。在联系之前，请准备好您的购买凭证，因为这可能将会在服务期间需要。

阅读时，请注意以下图标：



此图标注意事项必须阅读、理解并遵守，以防止使用过程中产品受到损伤等。



此图标包含更多相关信息。

1.1 包装清单

1. 主机盖 x 1
2. 主机 x 1
3. 遥控器 x 1
4. 手柄 x 2
5. 手柄配件 x 1
6. 快拆螺丝 x 2
7. 手柄支架 x 1
8. 电池 x 1
9. 电池充电器 x 1
10. 防水圈 (备用) x 1
11. 遥控器充电线 x 1
12. 防丢绳 x 1
13. 合格证 x 1
14. 使用说明书 x 1



图 1

1.2 安全警告

LEFEET S1 的设计考虑到了用户的安全最大化。然而与任何电子运动产品一样,LEFEET S1 的使用也会有一定的风险(例如:失控)。因此,阅读和遵守《使用说明书》中的所有指示和警告,并在使用时做出良好的判断是非常重要的。

我们将使用 LEFEET S1 产品的行为视为用户承认并接受使用 LEFEET S1 时所产生的所有相关风险和责任,这些风险包括但不限于肌肉损伤、骨折、撕裂或其它严重伤害。使用 LEFEET S1 需自行承担风险。由于缺乏常识而发生的意外事故,一律概不负责。

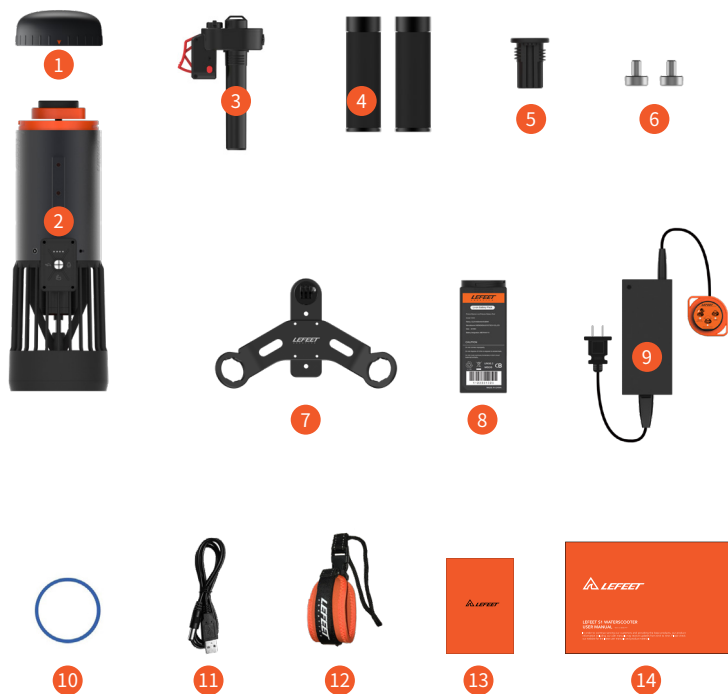
为了更好地确保您的安全,请阅读并遵循《使用说明书》中的所有指示和警告。



- 本产品为娱乐设备,不作为救生用途。
- 本产品只可以在水中使用。请勿让产品在空气中空转,以免电机因过度发热而烧坏。
- 本产品的任何配件都不可接近火源,不可重压。
- 本产品的使用环境温度条件为 $0^{\circ}\text{C}\sim 40^{\circ}\text{C}$,本产品的任何配件的存储环境温度条件为 $-10^{\circ}\text{C}\sim 50^{\circ}\text{C}$ 。
- 产品表面不得接触挥发性物质、酸性物质、腐蚀性物质或尖锐物品等。
- 在产品装有电池的情况下,不得将身体的任何部位或异物靠近螺旋桨。
- 售后服务和维修只能由授权中心进行,未经授权的维修会导致保修失效,同时,有引发人身安全和产品功能受损的风险。

- 14 岁以下人群不得使用本产品，14 周岁以上的未成年人必须在监护人的陪同下使用本产品。
- 身体状况不适合游泳、浮潜、潜水等运动的人士请勿使用本产品。
- 在受酒精或者药物影响的情况下，不得使用本产品。
- 使用本产品前，应确保该水域适合进行游泳、潜水等活动，且允许使用本产品。
- 使用本产品前，应检查产品表面未损坏、电池未损坏、螺旋桨正常工作，确保产品有足够电量让您安全返回岸边。
- 使用本产品进行潜水前，请确认您具备潜水资格，必须配备救生设备，做好防护措施，在有陪同的情况下进行。
- 如果您不会游泳，请务必穿着救生衣或配备救生设备且在浅水区使用本产品，并有救生员或游泳教练在场。
- 使用本产品时，请穿着救生衣或配备救生设备，戴上泳帽，不要穿着宽松的衣物，并与周围长头发或穿宽松衣物的人保持安全距离，避免长发或衣服卷入螺旋桨。
- 使用本产品时，请紧握手柄，不要将本产品的前部及尾部对准您或他人的脸部，尤其是眼睛。
- 使用本产品时，应注意观察周围环境，避免发生碰撞，不要让藻类、绳索或其他杂物缠绕螺旋桨。
- 请勿在海滩使用本产品，以免沙子、贝壳或其他杂物卷入螺旋桨。
- 禁止使用本产品下潜深度超过 40 米。
- 请使用本机充电器进行充电，不允许使用其它充电器。
- 电池充电时，周围环境的温度范围应应为 $10^{\circ}\text{C}\sim 45^{\circ}\text{C}$ 。
- 电池不可拆解、改装，不可受到强烈的震动、冲击，电池装入后，请轻拿轻放。
- 电池不可受潮，电池金属插座不可沾到任何液体。您组装、拆卸、储存电池时，请保持本产品及您的双手是完全干燥的，并在干燥的环境中进行。
- 如果在使用或充电时，电池发出一种不寻常的气味，发热，改变颜色、形状变异，或以任何其他方式出现的异常，请立即停止使用或充电。如在储存电池时发生上述异常情况，请检查储存环境。
- 请勿将电池放进微波炉、高压容器或电磁炉里。
- 切勿将电池长时间存放在高温室外的车内。
- 电池液会对眼睛造成伤害，请勿用尖锐物品刺穿电池。如果电池发生泄漏，电池液进入眼睛，请不要揉搓眼睛，应用大量清水冲洗，并立即就医。

II - 产品特性

2.1 产品图示



图 2

2.2 遥控器图示



图 3

III - 组装

3.1 手柄组装



- 产品使用前，请确保手柄和遥控器已紧固在手柄支架上。
- 本步骤说明仅针对惯用右手使用者，实际可根据使用者习惯自行调整遥控器左右位置。

- 步骤 1.** 从包装中取出两个手柄、遥控器、手柄配件、手柄支架。
- 步骤 2.** 注意核对好遥控器安装的前、后方向，使遥控器有动力开关的一面背向自己（图 4）。
- 步骤 3.** 将遥控器插入手柄支架右侧的孔内，与其中一个手柄对准插入。
- 步骤 4.** 插入手柄时逆时针旋紧手柄。
- 步骤 5.** 将手柄配件插入手柄支架左侧的孔内，与另一个手柄对准旋紧。



图 4



图 5

3.2 手柄支架与主机组装

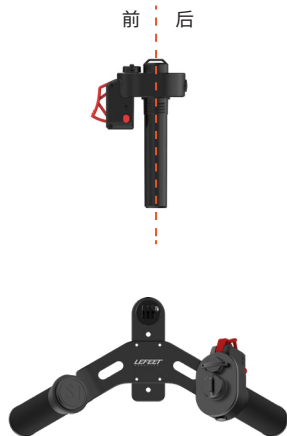
步骤 1. 使支架轨道与主机轨道对齐，将手柄支架沿轨道滑至主机上，直至两者的螺丝孔洞对齐。

步骤 2. 取出两颗快拆螺丝，将其紧固在主机上（可使用硬币或类似物件进行安装）。



图 6

3.3 组装或拆卸电池

- 步骤 1.** 打开电池舱盖，将电池装入电池舱（图 7）。
- 步骤 2.** 对齐电池舱盖上的插销和电池上的插槽，然后将电池舱盖盖紧。
- 步骤 3.** 确保电池舱盖已压紧，顺时针旋转 45° 锁定电池。
逆时针旋转时，电池将解锁（图 8）。
- 步骤 4.** 将主机盖顺时针旋紧于主机顶部（图 9）。
将主机盖上的橙色箭头对齐主机上的“OPEN”字样，压下，顺时针旋转；当橙色箭头旋至“LOCK”并发出“嗒”声响，表示锁紧。
- 步骤 5.** 反向操作以取出电池。

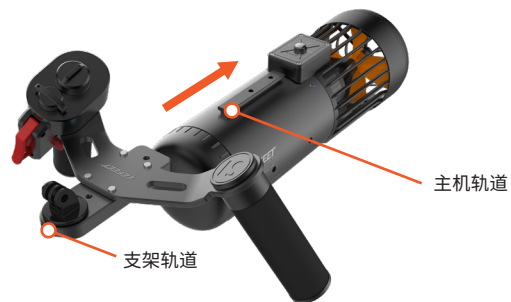

图 7



图 8



图 9

IV - 充电

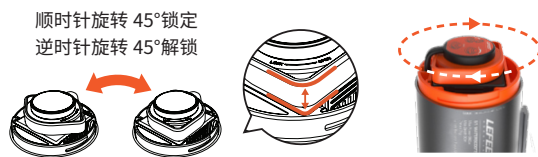

- 首次使用前，请务必将电池充满电。
- 将电池从主机取出前，请确保主机处于关机状态（参见第 3.3 节）。

4.1 如何为 LEFEET S1 充电

- 步骤 1.** 将电池充电器的插头端 (a) 连接到交流电源 (100V-240V；如有需要，请使用电源转换插头)。
- 步骤 2.** 将电池充电器另一端的插销 (b) 与电池的插槽对齐扣上，并旋紧。
- 步骤 3.** 充电器指示灯亮红色，说明电池电量未充满，亮绿色说明电池已充满。充满电约需 2.5 个小时。



图 10



- 不充电时请将电池充电器插头拔下。

4.2 如何为遥控器充电

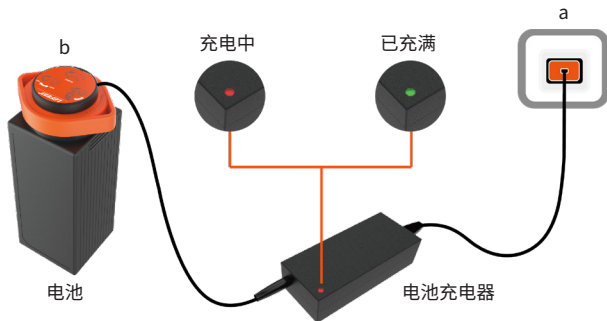

- 充电前，请确保遥控器已经关闭。
- 正在充电时，不要对遥控器进行任何操作。

- 步骤 1.** 按箭头方向旋转遥控器顶部的充电口盖即可将其拆下。
- 步骤 2.** 请用 **5V/1A 电源适配器或标准 USB 口充电器进行充电（不提供）**。
将遥控器充电线一端插入遥控器，另一端插入 USB 充电端口。
- 步骤 3.** 当遥控器完全充满电时，指示灯变绿色，这时应断开连接。充满电约需 1.5 个小时。
- 步骤 4.** 充电完成后，请将遥控器充电口盖盖回并旋紧。





图 11

V - 如何使用

5.1 如何使用你的 LEFEET S1

步骤 1. 使用前请确认 **动力开关锁** 已处于解锁状态（**动力开关**可正常按下）。

步骤 2. 分别长按遥控器和主机上的 **电源按钮 / 换档按钮** 约 1 秒，直到两者的指示灯都亮起，即为开机成功。

步骤 3. 短按遥控器或主机其中一个的 **电源按钮 / 换档按钮**，可切换三种速度模式（低档 ，中档 ，高档 ）*。

续航时间：30 ~ 60 分钟（正常使用）

***注：**随着电池电量消耗，动力将逐渐减弱，会出现自动降速跳转档位或无法使用高档或中档的情形。此情形视为正常适用范畴。

步骤 4. 按下 **动力开关**，推进器运转，松开则运转停止。

步骤 5. 需要关闭电源时，再分别按下主机和遥控器上的 **电源按钮 / 换档按钮** 开关约 1 秒即可。



图 12



· 如果主机与遥控器 15 分钟内无操作则会自动关机。

5.2 如何系挂防丢绳



· 防丢绳仅适用于在水下时防止产品脱手，不适用于在岸上提带产品。

步骤 1. 将防丢绳从卡扣处拆分成 a、b 两个部分（图 13）。

步骤 2. 撕开 a 部分的魔术贴，将腕带光滑的一面沿手腕环绕，把魔术贴伸进扣环里并按压贴紧（图 14）。

步骤 3. 把 b 部分穿进手柄支架的孔洞中并系紧（图 15）。

步骤 4. 将 a、b 两个部分的卡扣扣紧（图 16）。



图 13



图 14



图 15



图 16

5.3 如何使主机与遥控器配对

出厂时，遥控器与主机已默认配对。如果没有，请参照以下步骤进行配对。

- 步骤 1.** 长按遥控器上的 **电源按钮 / 换挡按钮** 约 5 秒，电源指示灯亮白灯快速闪烁，说明遥控器进入配对模式。
- 步骤 2.** 长按主机上的 **电源按钮 / 换挡按钮** 约 5 秒，直到三种速度模式指示灯开始快速闪烁，表示主机进入配对模式。
- 步骤 3.** 当主机的速度模式指示灯停止闪烁，主机螺旋桨会短暂旋转，表示主机与遥控器配对成功。
- 步骤 4.** 短按遥控器的动力开关按钮或 **电源按钮 / 换挡按钮**，遥控器指示灯停止白灯闪烁变成绿灯，退出配对模式。



图 17



- 单个遥控器也可配对多台主机，操作方法同上。

VI - 维护

为了本产品性能可以保持良好状态，请在每次使用后参照以下步骤进行维护：

- 步骤 1.** 将本产品完全浸入盛满清水（非海水）的容器中，浸泡时长大致为 30 分钟。
- 步骤 2.** 双手握住操作手柄，在本产品完全浸入的状态下，开机慢速运转一分钟，反复运转 2~3 次。
- 步骤 3.** 用柔软清洁的干布擦干机身。
- 步骤 4.** 打开主机盖，擦干电池舱外围的水珠，在双手干燥的状态的打开电池舱盖，取出电池。
- 步骤 5.** 将机身和电池放在阴凉通风处完全晾干。

6.1 清理事项

如果遇到螺旋桨缠绕异物，可将主机的螺旋桨后盖打开进行清理。



- 确保在电源关闭且电池取出的情况下操作。
- 清理螺旋桨异物时注意不要划伤手指。
- 螺旋桨为重要配件，清理时应多加小心。

步骤 1. 将主机后端螺旋桨的桨罩盖逆时针旋转并向外拉开（注意旋转力度避免损坏产品）。

步骤 2. 旋转螺旋桨以便清除异物。

步骤 3. 取出异物后，反向操作安装。



图 18

6.2 存放

- 不要将 LEFEET S1 在高温低温、过于干燥潮湿、阳光直晒、尘土飞扬等环境中存放，恶劣的环境会对电子设备造成损坏。
- 在存放 LEFEET S1 之前，请将电池充满电，防止电池因不使用而过度放电。
- 如果长期不使用，则每三个月对电池进行一次充电。
- 存放温度不得超过 $-10^{\circ}\text{C} \sim 50^{\circ}\text{C}$ 的范围。

6.3 设备处理

本产品不得焚烧、填埋或与家庭垃圾混合处理。不当处置本产品所含电池，可能导致电池发热、断裂或起火，造成严重伤害。电池内的物质对环境构成化学风险。建议在使用寿命结束时，对 LEFEET S1 进行电子垃圾或有害垃圾回收。

有关锂离子电池 / 含有锂离子电池的产品的回收和处置的地方法规和法律将根据国家和地方政府的不同而有所不同。您必须检查您所居住地方相对应的法律法规，以便正确处理产品电池电芯。用户有责任按照当地法规和法律妥善处理其废弃物设备。

如需更多有关电池、电器或电子废物应放在何处的资料，请联络本地或区域废物管理办事处、家居废物处理服务或销售点。

VII - LEFEET S1 规格

	项目	参数
主机	重量	2.3 kg (含电池)
	尺寸	315 x 300 x 164 mm (含手柄支架)
	工作温度	0° C ~ 40° C
	防水深度	40 m
	可调档位	三档: 高档 / 中档 / 低档 *
	续航时间	30 ~ 60 mins (正常使用) *
	推力	7 kgf
	外挂支持	支持挂载运动相机 *

- * 注: 1. 随着电池电量消耗, 动力将逐渐减弱, 会出现自动降速跳转档位或无法使用高档或中档的情形。此情形视为正常适用范畴;
2. 本数据仅供参考。具体使用时长会因不同档位、使用者体重、使用环境及使用频率而有所变化;
3. 本产品自带的相机底座仅支持部分型号运动相机, 运动相机需自行购买。

电池	充电电压	25.2 V
	充电电流	3 A
	额定容量	4400 mAh
	额定能量	97.68 Wh
	充电温度	10° C ~ 45° C
	充电时长	~ 2.5 h
	重量	760 ± 20 g
电池充电器	输入电压	100 ~ 240 V
	输出电压	25.2 V
	输出电流	3 A

保修服务

尊敬的客户：

LEFEET 朗非创新保证，您购买的 LEFEET S1 产品均按照合格的标准进行设计和制造，在正常使用情况下，在保修期内没有功能缺陷。如果您在使用产品的过程中遇到任何困难，建议您先查阅产品的用户手册，您也可以在我们的网站上下载到用户手册、常见问题解答、教学视频或支持论坛。

服务范围

您的 LEFEET S1 包含为期一年的硬件保修服务。本产品的保修期从销售发票开具当日算起，主机保修期限为 12 个月，主机电池保修期限为 6 个月。若您无法提供购买发票等有效证据，则保修起始日期以机器所示的生产日期向后顺延 90 个自然日或由 LEFEET 朗非创新另行规定。

如果维修不可行或者商业上不可行，我们可能会使用具有类似功能的新产品或者翻新产品来替换此产品。在维修、固件升级或者更换后，更换的产品或配件在原产品剩余的保修期内享有同等的保修服务。

如何获得售后服务

在保修期间，若产品不能实现所保证的功能，请联系我们的客服邮箱：service@lefeet.com 以获取相应的售后服务。

LEFEET 朗非创新可能在某些地区不提供售后服务，且售后服务政策的内容也可能因地而异。常规服务范围外的服务可能需要另行收费。如欲了解本地信息，请联系 LEFEET 朗非创新客服。

获得售后服务的准备工作

联系 LEFEET 朗非创新后，请您详细说明产品存在的问题。

LEFEET 朗非创新技术支持人员将尝试通过电话、电子邮件、或远程协助来诊断和解决您的问题。如果通过电话无法解决您的问题，您需将产品寄回 LEFEET 朗非创新进行进一步检测。LEFEET 朗非创新会按产品享有的保修服务安排维修。

更换产品和部件

如果保修服务涉及更换产品或部件，那么被更换的产品或部件将成为 LEFEET 朗非创新的财产，而更换的产品或部件将成为您的财产。只有未经改动的 LEFEET S1 和部件方可进行更换。

LEFEET 朗非创新提供的更换产品或部件可能不是全新的，但它们肯定处于良好的工作状态，并至少在性能上与被更换件等同。更换的产品或配件在原产品剩余的保修期内享有同等的保修服务。

个人联系信息的使用

如果您根据本保修条款获取服务，即表示您授权 LEFEET 朗非创新存储、使用和处理您的联系信息，包括姓名、电话号码、地址和电子邮件地址等。LEFEET 朗非创新可利用这些信息开展本政策项下的服务。我们可能会联系您，询问您对我们的保修服务是否满意，或就任何产品召回或安全问题向您发出通知。为实现上述目标，您授权 LEFEET 朗非创新将您的信息转移到我们开展业务的任何国家或地区，并可以将其提供给我们的代表机构。如果法律要求，我们也可以披露这些信息。

非售后政策保障范围

本政策不包括或者不适用以下情况：

- 发生人为的非产品本身质量问题导致的碰撞、烧毁事故；
- 发生非官方说明书指导的私自改装、拆解、开壳等行为而造成的损坏；
- 未按说明书指导的不正确安装、使用及操作所造成的损坏；
- 在无官方说明指导的情况下，客户自行维修或者请未经官方授权的服务机构维修 / 修改部件导致的损坏；
- 因非官方说明书指导的电路改造、或电池组、充电器的匹配使用不当导致的损坏；
- 滥用产品或者在不符合产品用户手册中环境条件下操控导致的损坏；
- 由于连接用户手册推荐产品之外的外设、附加设备或者附件造成的损坏；
- 在电量不足时、或使用存在质量问题的电池导致放电不足而产生的损坏；
- 装置已经损坏，包括但不限于由于动物、雷电、异常电压、火灾、自然灾害、运输造成的损坏；
- 改动或撕下识别标签的产品或部件导致产品上的型号、序列号、或者生产日期已涂改、去除或者无法被辨认；
- 产品因未在最初设计、制造或者批准使用的国家 / 地区使用而无法正常工作；
- 对于您在产品上使用的第三方应用程序。

责任限制

LEFEET 朗非创新仅在下列情况下对产品的丢失或损坏负责：产品已为 LEFEET 朗非创新所拥有；或产品在 LEFEET 朗非创新运输的途中。

对于以下情况，无论本文规定的任何救济是否达到其根本目的，也不论索赔是基于合同、担保、疏忽、严格责任或其它责任理论，LEFEET 朗非创新及其关联企业、供应商、经销商或服务供应商概不负责：1) 第三方向您提出损害索赔；2) 特别的、附带的、间接的或继发的损害，包括但不限于利润、业务收入、商誉或预期可节省金额等方面的损失。

无论损害基于任何原因，LEFEET 朗非创新及其关联企业、供应商、经销商或服务供应商的全部责任仅限于您实际遭受的直接损失，并且不高于您购买产品付出的金额。



LEFEET
LEFEET S1 WATERSCOOTER

